



VPS

Parts Listing

Document No. 588641 Revision H, dated June 2016

© Copyright 2011-2016 Heraeus Noblelight America LLC
All Rights Reserved.

Heraeus Noblelight America LLC
910 Clopper Road
Gaithersburg, MD 20878-1357 USA
301-527-2660 • FAX 301-527-2661

Heraeus Noblelight America LLC reserves the right to make changes without prior announcement.

VPS REPLACEMENT PARTS

This document replaces any parts listings that may be contained within the VPS Installation, Operation, and Maintenance Manual.

Contained within this document are the part numbers for your genuine Heraeus UV parts. Heraeus Noblelight America LLC (formerly Fusion UV Systems) received full ISO certification in 1993 and we maintain that certification today to the ISO 9001:2008 standard, which underscores our commitment to providing the highest quality components, systems, support, training, process development, and after sales service.

For the most current Replacement Parts Listing for the VPS system, please visit:

<http://www.heraeus-noblelight.com/spareparts>

On-Line Store

Customers can now place parts orders online*. Our Web Store provides a new level of efficiency and convenience and features:

- 24/7 access
- fully secure website
- pictorial catalog of parts
- ability to review open or closed parts orders, invoices, and returns
- ability to track your parts shipments
- A discount is given for ALL parts ordered online

If you are not yet registered for the Web Store but would like to do so, please contact Sales Support on 1-301-990-8600 or salesupport.hna.uvp@heraeus.com.

- * Only customers who place orders directly with Heraeus Noblelight America LLC may register for the online store. If you currently order parts through a local Heraeus Noblelight distributor, please contact them directly for all parts orders.

Customer Support

The following groups within Heraeus Noblelight America LLC are available to provide customer support.

Sales Support

The Sales Support group is responsible for the processing of domestic and international quotation requests as well as the purchase orders of spare parts, systems, and online orders.

Contact Sales Support at salesupport.hna.uvp@heraeus.com.

Technical Service

The Technical Service group is responsible for worldwide after sales support including repair services whether returned to a Heraeus Noblelight Service Center or at the customer site. This group also provides new equipment commissioning, maintenance and operator training, telephone/email/fax support, maintenance programs such as multi-level service contracts, and certified rebuilt equipment. Our service staff averages nearly 16 years of hands-on experience with Fusion UV equipment!

Contact Technical Services at techservice.hna.uvp@heraeus.com.

Applications Engineering

The Applications Engineering group concentrates on the optimization of a customer's UV process or proposed process and in assisting customers with troubleshooting of their UV curing process. Their expertise includes system selection and configuration; determination of system size, lamp type, and optics; machine design concepts, integration; and air handling systems and measurement (radiometry and thermometry).

This group oversees and operates the Applications Lab in which processes can be developed, demonstrated, or refined using any of a wide range of UV exposure equipment available, including all lamp and bulb types.

Contact Applications Engineering at info.hna.uvp@heraeus.com.

Irradiator Models



I600M and I250B Irradiators

The various irradiator models manufactured by Heraeus Noblelight are listed below.

Irradiator Models

Irradiator Model	Connectors	Air Delivery
I600M/I250	Front Connections	Top Connect Plenum
I601M/I251	Top Connections	Top Connect Plenum
I602M/I252	Front Connections	Rear Connect Plenum
I603M	Top Connections	Rear Connect Plenum
I606M/I256	Front Connections	Rear Connect Plenum with alignment slots for tower mounting
I250B	Front Connections	Integral blower

PM Kits

There are two types of Irradiator Preventive Maintenance kits available: Basic and Deluxe. The Basic PM kit contains a UV bulb, RF screen, and R500 reflector. This kit is for the routine maintenance inspections. The Deluxe PM kit contains UV bulb, QCS RF screen, R500 reflector, magnetron pair, photodetector, and pressure switch. This kit is for a complete irradiator rebuild.

Basic PM Kits

Irradiator	Description	Heraeus Part Number
1600M	I600M Basic PM kit, contains 13 mm UV bulb (BT13H), QCS RF screen kit, and QCS R500 swept reflector kit with elastomer gaskets	80130865
	I600M Basic PM kit, contains 13 mm UV bulb (BT13D), QCS RF screen kit, and QCS R500 swept reflector kit with elastomer gaskets	80130866
	I600M Basic PM kit, contains 13 mm UV bulb (BT13H+), QCS RF screen kit, and QCS R500 swept reflector kit with elastomer gaskets	80130867
	I600M Basic PM kit, contains 13 mm UV bulb (BT13H), QCS RF screen kit, and QCS R500 non-swept reflector kit with elastomer gaskets	80130868
	I600M Basic PM kit, contains 13 mm UV bulb (BT13D), QCS RF screen kit, and QCS R500 non-swept reflector kit with elastomer gaskets	80130869
I250	I250 Basic PM kit, contains 9 mm UV bulb (BL9H7), QCS RF screen kit, and QCS R500 swept reflector kit with elastomer gaskets	80130863
	I250 Basic PM kit, contains 9 mm UV bulb (BL9D7), QCS RF screen kit, and QCS R500 swept reflector kit with elastomer gaskets	80130864

Deluxe PM Kits

Irradiator	Description	Heraeus Part Number
1600M	I600M Deluxe PM kit, contains 13 mm UV bulb (BT13H), QCS RF screen kit, QCS R500 swept reflector kit with elastomer gaskets, magnetron kit, photocell, and pressure switch	80132591
	I600M Deluxe PM kit, contains 13 mm UV bulb (BT13D), QCS RF screen kit, QCS R500 swept reflector kit with elastomer gaskets, magnetron kit, photocell, and pressure switch	80135608
	I600M Deluxe PM kit, contains 13 mm UV bulb (BT13H+), QCS RF screen kit, QCS R500 swept reflector kit with elastomer gaskets, magnetron kit, photocell, and pressure switch	80132592
	I600M Deluxe PM kit, contains 13 mm UV bulb (BT13H), QCS RF screen kit, QCS R500 non-swept reflector kit with "209" end reflectors and elastomer gaskets, magnetron kit, and photocell	80135609
I250	I250 Deluxe PM kit, contains 9 mm H bulb (BL9H7), QCS RF screen kit, QCS R500 swept reflector kit with elastomer gaskets, I25x magnetron kit, photocell, and pressure switch	80132590
	I250 Deluxe PM kit, contains 9 mm D bulb (BL9D7), QCS RF screen kit, QCS R500 swept reflector kit with elastomer gaskets, I25x magnetron kit, photocell, and pressure switch	80135607

Irradiator Parts Lists

I600M Replacement Bulb Part Numbers

I 600M Bulb Part Numbers

Bulb Type	Description	Heraeus Part Number
H bulb	Bulb, UV, BT13H, single bulb (standard)	558472
	Bulb Kit, 10", BT13H, 13 mm, 1 bulb *	558482
	Bulb Kit, 10", BT13H, 13 mm, 2 bulbs *	570242
	Bulb Kit, 10", BT13H, 13 mm, 3 bulbs *	570252
D bulb, 13 mm	Bulb, UV, BT13D, single bulb (optional)	558474
	Bulb Kit, 10", BT13D, 13 mm, 1 bulb *	558484
	Bulb Kit, 10", BT13D, 13 mm, 2 bulbs *	570244
	Bulb Kit, 10", BT13D, 13 mm, 3 bulbs *	570254
D bulb, 11 mm	Bulb, UV, BT11D, single bulb (optional)	558454
	Bulb Kit, 10", BT11D, 11 mm, 1 bulb *	558464
	Bulb Kit, 10", BT11D, 11 mm, 2 bulbs *	570224
	Bulb Kit, 10", BT11D, 11 mm, 3 bulbs *	570234
V bulb	Bulb, UV, BT13V, single bulb (optional)	558477
	Bulb Kit, 10", BT13V, 13 mm, 1 bulb *	558487
	Bulb Kit, 10", BT13V, 13 mm, 2 bulbs *	570247
	Bulb Kit, 10", BT13V, 13 mm, 3 bulbs *	570257
H+ bulb	Bulb, UV, BT13H+, single bulb (optional)	558471
	Bulb Kit, 10", BT13H+, 13 mm, 1 bulb *	558481
	Bulb Kit, 10", BT13H+, 13 mm, 2 bulbs *	570241
	Bulb Kit, 10", BT13H+, 13 mm, 3 bulbs *	570251
Q bulb	Bulb, UV, BT13Q, single bulb (optional)	558478
	Bulb Kit, 10", BT13Q, 13 mm, 1 bulb *	558488
M bulb	Bulb, UV, BT13M, single bulb (optional)	558475
	Bulb Kit, 10", BT13M, 13 mm, 1 bulb *	558485
Lab Kit	Bulb Lab kit (contains one each of BT13H, BT13D, and BT13V) *	570352

* Bulb kits contain bulb(s), polyethylene glove, alcohol swab, RF screen screws, and instructions.

I25x Replacement Bulb Parts Numbers

I25x Replacement Bulb Part Numbers

Bulb Type	Description	Heraeus Part Number
H bulb	Bulb, UV, BL9H7, 9 mm single bulb (standard)	558492
	Bulb Kit, 10", BL9H7, 9 mm, 1 bulb *	558502
	Bulb Kit, 10", BL9H7, 9 mm, 2 bulbs *	570262
	Bulb Kit, 10", BL9H7, 9 mm, 3 bulbs *	570272
D bulb	Bulb, UV, BL9D7, 9 mm single bulb (optional)	558494
	Bulb Kit, 10", BL9D7, 9 mm, 1 bulb *	558504
	Bulb Kit, 10", BL9D7, 9 mm, 2 bulbs *	570264
	Bulb Kit, 10", BL9D7, 9 mm, 3 bulbs *	570274
V bulb	Bulb, UV, BL9V7, 9 mm single bulb (optional)	558497
	Bulb Kit, 10", BL9V7, 9 mm, 1 bulb *	558507
	Bulb Kit, 10", BL9V7, 9 mm, 2 bulbs *	570267
	Bulb Kit, 10", BL9V7, 9 mm, 3 bulbs *	570277
H+ bulb	Bulb, UV, BL9H+, 9 mm single bulb (optional)	558491
	Bulb Kit, 10", BL9H+, 9 mm, 1 bulb *	558501
	Bulb Kit, 10", BL9H+, 9 mm, 2 bulbs *	570261
	Bulb Kit, 10", BL9H+, 9 mm, 3 bulbs *	570271
A bulb	Bulb, UV, BL9A7, 9 mm single bulb (optional)	558493
	Bulb Kit, 10", BL9A7, 9 mm, 1 bulb *	558503
Q bulb	Bulb, UV, BL9Q7, 9 mm single bulb (optional)	558498
	Bulb Kit, 10", BL9Q7, 9 mm, 1 bulb *	558508
M bulb	Bulb, UV, BL9M7, 9 mm single bulb (optional)	558495
	Bulb Kit, 10", BL9M7, 9 mm, 1 bulb *	558505
Lab Kit	Bulb Lab Kit (contains one each of BL9H7, BL9D7, BL9V7)*	570353

* Bulb kits contain bulb(s), polyethylene glove, alcohol swab, RF screen screws, and instructions.

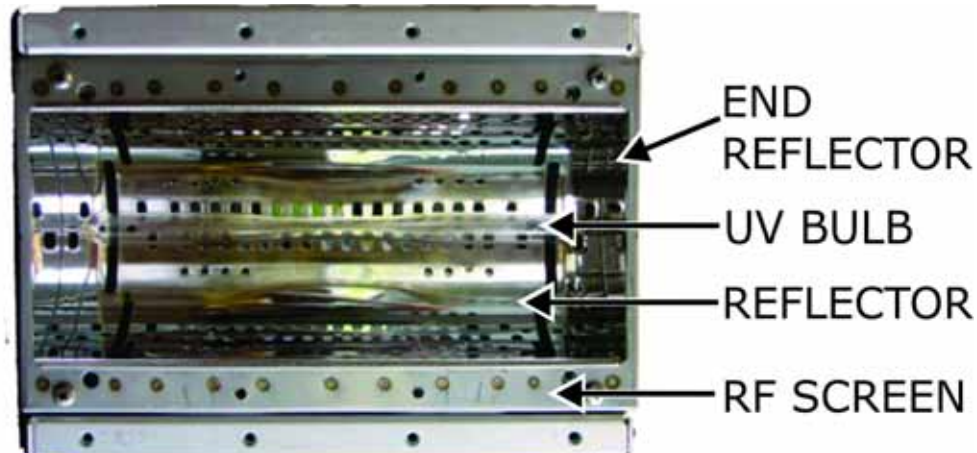

Irradiator Components, Bottom view

Reflector Replacement Part Numbers

Irradiator Type	Reflector Type	Description	Heraeus Part Number
	End	End Reflector Kit, R500 (1 pair) (standard) (includes elastomer gaskets)	80130626
		End Reflector Kit, R500 (1 pair), "209" hole location (includes elastomer gaskets)	80130627
I600M	R500	Reflector assembly kit, R500, swept (includes main reflector, two end reflectors, and elastomer gaskets), I600M	80130714
		Reflector assembly kit, R500, non-swept (includes main reflector, 2 end reflectors, and elastomer gaskets), I600M	80130715
	R500/"209"	Reflector assembly kit, R500, swept, "209" (includes main reflector, 2 "209" end reflectors, and elastomer gaskets), I600M	80130721
		Reflector assembly kit, R500, non-swept (includes main reflector, 2 "209" end reflectors, and elastomer gaskets), I600M	80130722
I25x	R500	Reflector assembly kit, R500, swept (includes main QCS reflector, two R500 end reflectors, and elastomer gaskets), I25x	80130717
		Reflector assembly kit, R500, non-swept (includes main QCS reflector, 2 R500 end reflectors, and elastomer gaskets), I25x	80130716
I600M	Dichroic	Reflector assembly kit, Dichroic, non-swept (cold/R500) (includes dichroic main reflector, 2 R500 end reflectors, and elastomer gaskets), I600M	80130719
		Reflector assembly kit, Dichroic, swept (cold/R500) (includes dichroic main reflector, 2 R500 end reflectors, and elastomer gaskets), I600M	80130720

Irradiator Type	Reflector Type	Description	Heraeus Part Number
I25x	Dichroic	Reflector assembly kit, Dichroic, non-swept (cold/R500) (includes dichroic main QCS reflector, 2 R500 end reflectors, and elastomer gaskets), I25x	80130718
I600M	Dichroic Plus	Reflector assembly kit, Dichroic Plus, non-swept (cold/R500) (includes dichroic main reflector, 2 R500 end reflectors, and elastomer gaskets), I600M	80130725
		Reflector assembly kit, Dichroic Plus, swept (cold/R500) (includes dichroic main reflector, 2 R500 end reflectors, and elastomer gaskets), I600M	80130726
I25x	Dichroic Plus	Reflector assembly kit, Dichroic Plus, non-swept (cold/R500) (includes dichroic main QCS reflector, 2 R500 end reflectors, and elastomer gaskets), I25x	80130723
		Reflector assembly kit, Dichroic Plus, non-swept "209" (cold/R500) (includes dichroic main QCS reflector, 2 R500 "209" end reflectors, and elastomer gaskets), I25x	80130724
I600M	Dichroic Plus "209"	Reflector assembly kit, Dichroic Plus, non-swept "209" (includes dichroic main reflector, 2 "209" end reflectors, and elastomer gaskets), I600M	80130727
		Reflector assembly kit, Dichroic Plus, swept "209" (includes dichroic main reflector, 2 "209" end reflectors, and elastomer gaskets), I600M	80130728
Gaskets	Gaskets	RF gasket kit, 10-inch systems (contains pairs of reflector end and reflector elastomer gaskets)	80130191
Hardware	Hardware	Kit, Reflector hardware (contains additional hardware for older-style screens)	80131353

NOTE: Reflector type is specified at the time of purchase. Swept reflectors are designed to direct ambient air flow away from the UV bulb and reflector. If you plan to replace a non-swept reflector with a swept reflector, you must verify that your cooling blower is adequately sized. Refer to the cooling requirements contained within the Product Manual. If your blower does not meet the cooling requirements for all connected lamp housings, you must increase the capacity of your cooling system. For assistance, consult Heraeus Noblelight Technical Service.

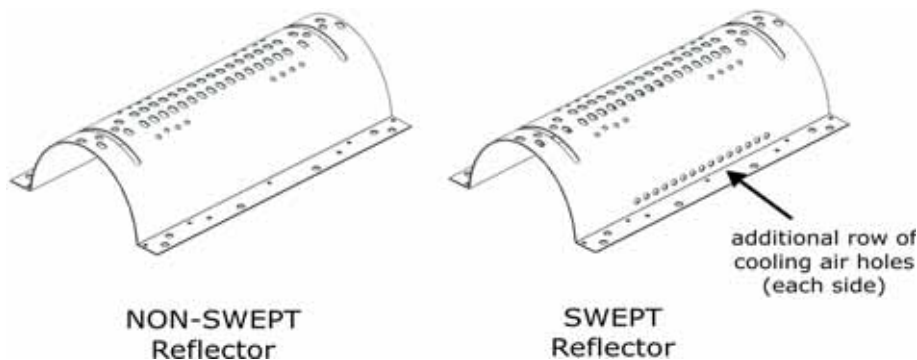

Non-Swept vs. Swept Reflectors

As shown in the Figure above, swept-type reflectors contain one additional row of cooling air holes per side. Swept reflectors help reduce fouling from contamination present in the curing zone under the lamp.

There is no need to use swept-type reflectors in quartz window or F10T/C10T applications since the reflector assembly is isolated from the curing zone. If swept reflectors are installed in these applications, blowers that provide additional pressure and flow are required.

Screen Replacement Part Numbers

Description	Heraeus Part Number
RF Screen assembly replacement kit, Quick Change Screen, 10-inch systems	581742

NOTE: The Quick Change Screen (QCS) and the associated reflector are factory installed on irradiators manufactured after May 2011. The new QCS screen will fit on existing reflectors; however, the screws will need to be replaced with the non-captive M3 screws provided in the replacement kit. The screen mounting holes on the new Reflectors have changed to allow use of the new QCS and the captive screws. The previous style screen (non-captive screws) will not fit on the new reflector.

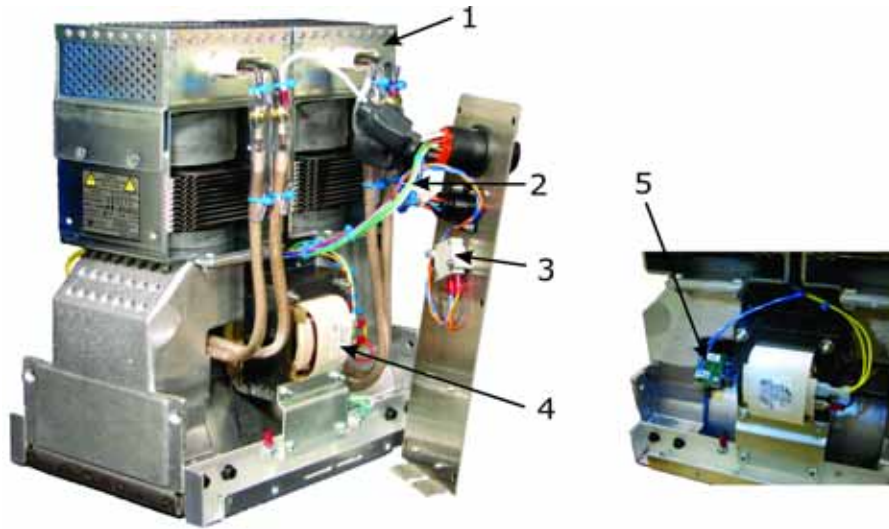

I600M Irradiator Components

I600M Irradiator Replacement Part Numbers

Item #	Description	Reference Designator	Heraeus Part Number
1	Magnetron Kit, I600M, pair	Mag A, Mag B	234323
2	Harness Assembly, I600M	J10/J11/J30	512691
3	Switch, Air Pressure	S201	26079
4	Transformer Kit, filament, 50/60 Hz	T201, T202	36505
5	Photodetector Assembly kit, direct view	A201	255063
Air Baffles / Air Flanges (not shown)	Air Baffle, I606M only	--	529132
	Air dam (located behind filament transformers)	--	276311
	Air Plenum/Flange Assembly, I600M	--	213912
	Air Plenum/Flange Assembly, I601M only	--	573901
	Air Plenum/Flange Assembly, I602M and I603M only	--	270811
not shown	Handle, utility	--	30397
not shown	Screw, socket head, M6 (2 per handle)	--	110821
not shown	Hex nut, plastic, HV connector	J10	254101
not shown	O-ring, silicone, I606 only (air plenum opening)	--	85975
not shown	Spring, compression, I606 only (for tower mounting)	--	511391
not shown	Bolt, captive, M8, I606 only (for tower mounting)	--	511181

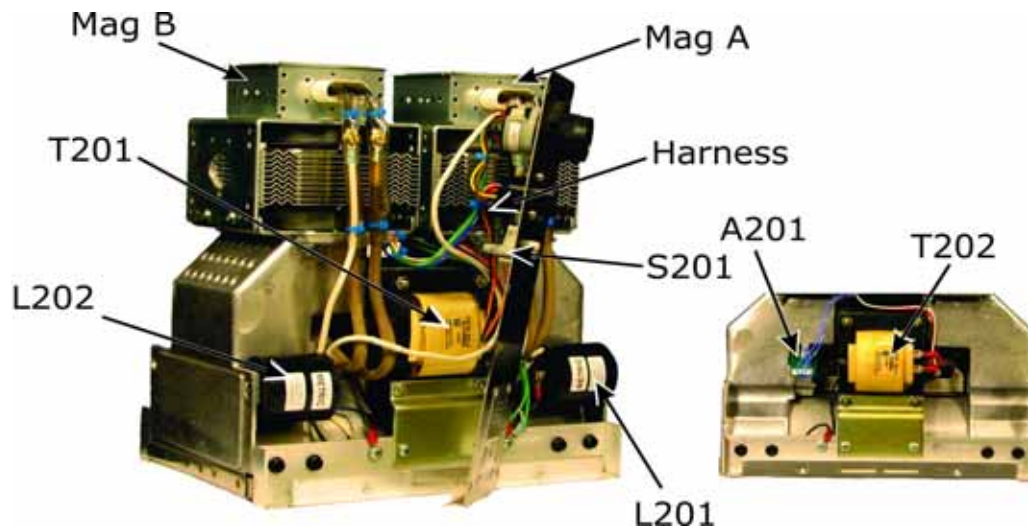

I250 Irradiator Components

I25x Irradiator Replacement Part Numbers

Reference Designator	Description	Heraeus Part Number
Mag A, Mag B	Magnetron Kit, I250, pair	256041
J10/J11	Harness Assembly, I25x	255183
S201	Switch, Air Pressure	26072
T201	Transformer Kit, filament, 50/60 Hz, I250, front, 7" leads	256021
T202	Transformer Kit, filament, 50/60 Hz, I250, rear, 12" leads	256022
L201/L202	Coil, RF Suppression	257261
A201	Photodetector Assembly kit, direct view	255063
Air Baffles / Air Flanges (not shown)	Air Baffle, I256M only	529131
	Air dam (located behind filament transformers)	276311
	Air Plenum/Flange Assembly, I250	213912
	Air Plenum/Flange Assembly, I251M only	573901
	Air Plenum/Flange Assembly, I252M only	270811
not shown	Handle, utility	30397
not shown	Screw, socket head, M6 (2 per handle)	110821
not shown	Hex nut, plastic, HV connector, J10	254101
not shown	O-ring, silicone, I256M only (air plenum opening)	85975
not shown	Spring, compression, I256M only (for tower mounting)	511391
not shown	Bolt, captive, M8, I256 only (for tower mounting)	511181

K250 Blower Parts

The K250 Blower is available only for use with the I250B irradiator.

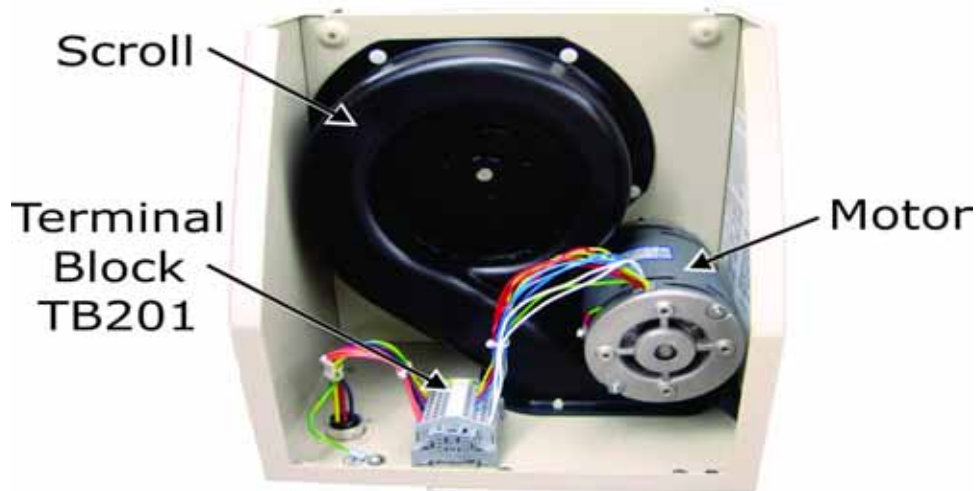

K250 Irradiator Components

K250 Blower Replacement Parts

Description	Heraeus Part Number
Bearing/shaft assembly	275231
Belt-timing, 5mm, Power Grip GT, 90 teeth	555071
Filter set, polyester, K250 (set of 5)	235908
Handle, chassis, pocket pull, K250	296252
Harness assembly	257062
Impeller, K250	271371
Motor, ½ HP, 50/60 Hz	245371
Pulley and belt kit, 60 Hz	275236
Pulley and belt kit, 50 Hz	275237
Pulley set screw, M4	555471
Rivet, nylon, 0.25 diameter (10 pieces)	275232
Scroll, replacement kit with rivets	275233
Terminal block, 1-Pole, 4 circuit, gray	254271
Terminal block, 1-Pole, 3 circuit, green/yellow (ground)	254276
Wheel, Blower, CW	587961
Retrofit kit - K250 Modular Blower for I250 irradiator system (includes K250 and components for 50/60Hz operation)	275701

VPS Replacement Parts

Reference Designator	Description	VPS-6 (380-480V)	VPS-4 (200-240V)	Heraeus Part Number
	Baffle-Cooling, polycarbonate	1	1	330011
C101-102	Capacitor, oil-filled, 250V, 160 MFD		2	297591
	Capacitor, oil-filled, 480V, 50 MFD	2		297592
CB100	Circuit Breaker, 2-pole, 4A, 480V	1		292223
	Circuit Breaker, 2-pole, 8A, 480V		1	528541
CB101	Circuit Breaker, 40A, 3-pole, 480V	1	1	302411
CB102	Circuit Breaker, 1.6A, 3-pole, 480V	optional		329713
	Circuit Breaker, 3A, 3-pole, 480V		optional	298853
	Clip, HV, wire	5	5	326632
K100	Contact kit, Power, 3-pole with auxiliary, 37A, 24 VAC coil	1	1	580341
	Control Panel Assembly with overlay	1		291551
PWB	Control PWB Assembly Kit	1		80130229
TH2, TH3	Diode, Dual SCR Model, 1400V, 40A	2	2	291941
F1, F2, F3 (HV PWB)	Fuse, 250V, 4A, Slow-blo, 5x20 mm, 150A interrupt capacity	3	3	341197
	HV Diode Assembly	2	2	328764
PWB	HV PWB Assembly Kit	1		80126781
	Knob, Power Level	1	1	296691
	Lanyard, VPS Door	1	1	326612
	LCD Assembly Kit	1	1	325061
SW101	Limit Switch, SPDT, Door interlock	1	1	26355
PWB	Mag PWB Assembly Kit	2		80130227
OPTIONAL	Modular Blower, 380-480V (K250 only) Kit	1 (optional)		296111
OPTIONAL	Modular Blower, 200-240V (K250 only) Kit		1 (optional)	296112
B101, B102	Muffin Fan, 24 Vdc, 230 cfm	2	2	589471
S100	Rocker Switch, DPST, 250V, 4A	1	1	292241
T100	Transformer, Control	1	1	501921
T101-106	Transformer Kit, HV, 200-480V, 50/60 Hz	6	4	582084
VR1, VR2	Varistor, 10KV	2		302641

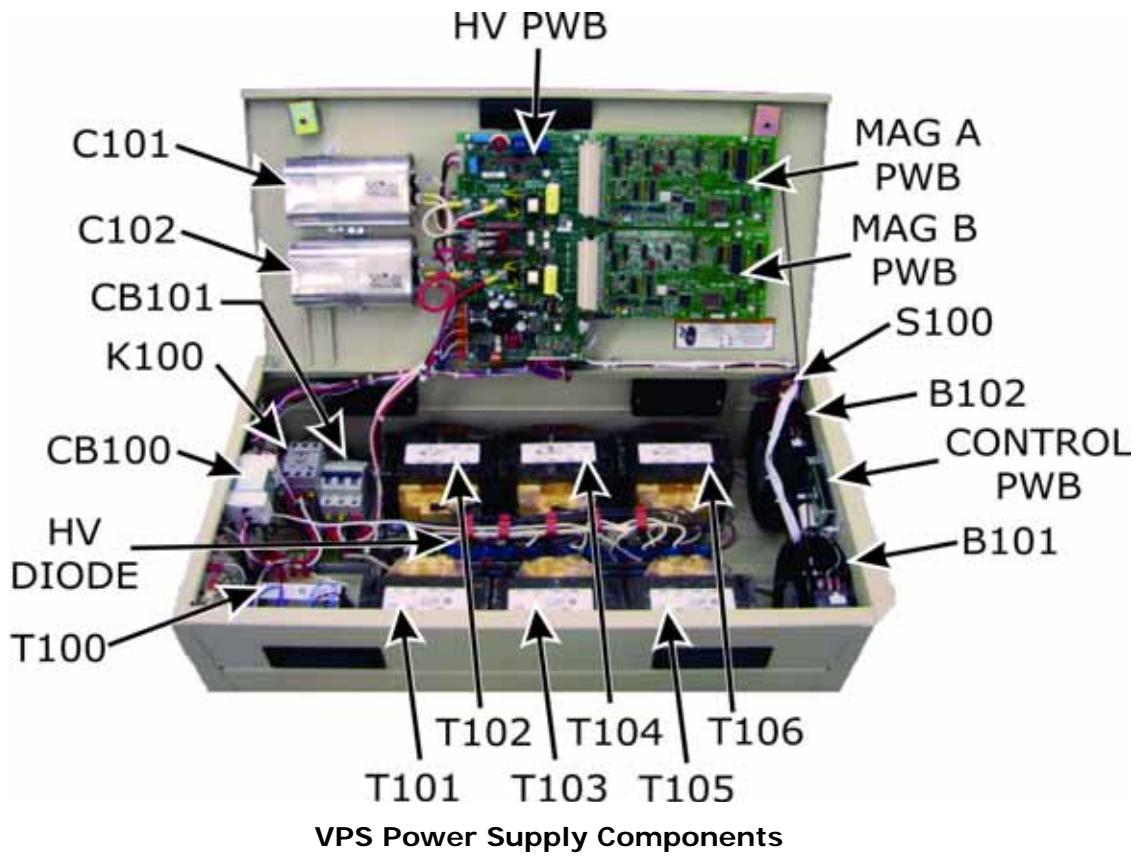

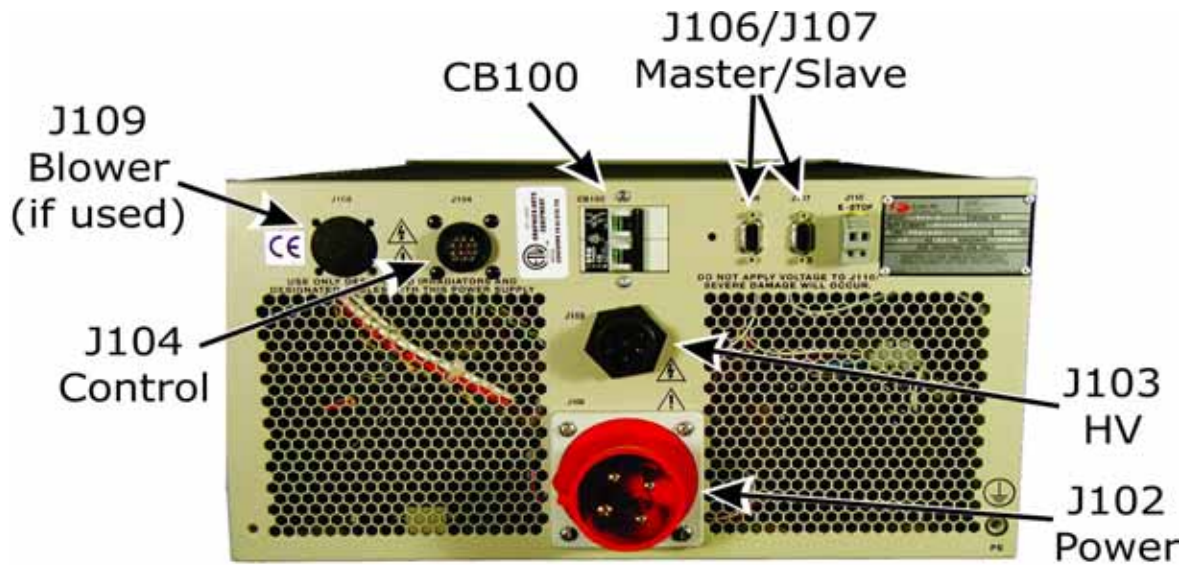

VPS Power Supply Components (Rear)

VPS Cable, Harness, and Wires Assembly Part Numbers

Reference Designator	Description	Heraeus Part Number
J103, J104	Mega Harness Assembly	570611
J102	Power Distribution Harness Assembly, 3-phase, European Plug	291721
J102	Power Distribution Harness Assembly, 3-phase, Domestic Plug	291722
	Wire Assembly, HV, Black, 8 inch	579932
	Wire Assembly, HV, Black, 15 inch, VPS-6	330486
	Wire Assembly, HV Transformer, Jumper, White	291623
	Wire Assembly, HV, White, 8 inch	579931
	Wire Assembly, HV, White, 15.6 inch	579951
	Wire Assembly, T100, Jumper, Blue	291622
	Wire Assembly, Transformer, Daisy Chain, Black, VPS-6	302484
	Wire Assembly, Transformer, Daisy Chain, Red, VPS-6	302486
	Wire Assembly, Transformer, Daisy Chain, White	302485

Connectors and Contacts

Reference Designator	Description	Heraeus Part Number
P102	Connector Plug, IEC-309, 415V	241974
	Connector Plug, IEC-309, 480V	241977
J10/P10 Adapter	Adapter, HV Connector, J10/P10, right angle, 0°	509411
	Adapter, HV Connector, J10/P10, right angle, 90°	509412
	Adapter, HV Connector, J10/P10, right angle, 180°	not applicable
	Adapter, HV Connector, J10/P10, right angle, 270°	509414
—	HV Connector Collar repair kit	323841
—	Tool, contact removal	43031

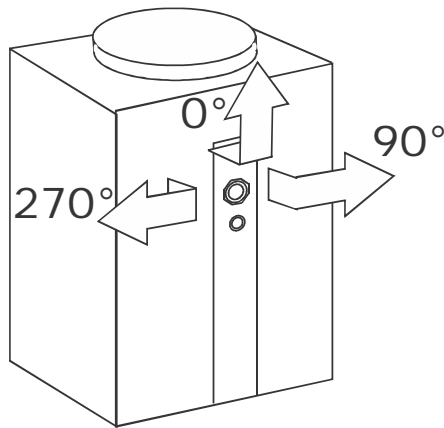

Right Angle Connectors

Miscellaneous Parts

Reference Designator	Description	Heraeus Part Number
RF-1	RF Detector Kit, Heraeus Noblelight	79961UV
	Terminating Resistor Assembly	297581

VPS Accessories

Reference Designator	Description	Heraeus Part Number
CUST I/O 1 (min) per row 4 (max) per row	Customer I/O Module without Enclosure, 5% steps	384141
	Customer I/O Module without Enclosure, 1% steps, 4-20 mA	384142
	Customer I/O Module without Enclosure, 1% steps, 0-10 VDC	384143
	Customer I/O Module with Enclosure, 5% steps	384151
	Customer I/O Module with Enclosure, 1% steps, 4-20 mA	384152
	Customer I/O Module with Enclosure, 1% steps, 0-10 VDC	384153
Multi-Row I/O 1 (min) per row 4 (max) per row	Multi-Row I/O Module without enclosure, 5% steps	Discontinued Contact HNA Sales or Service
	Multi-Row I/O Module without enclosure, 1% steps, 4-20 mA	
	Multi-Row I/O Module without enclosure, 1% steps, 0-10 Vdc	
	Multi-Row I/O Module with enclosure, 5% steps	
	Multi-Row I/O Module with enclosure, 1% steps, 4-20 mA	
	Multi-Row I/O Module with enclosure, 1% steps, 0-10 Vdc	
Customer I/O	Fuse, 16A, 250V, F1	384171
	Fuse, 0.63A, 250V, F2	513802
Multi I/O	Fuse, 1A, 250V	513801

Optional Accessories

Description	Heraeus Part Number
Kit, 1% retrofit, 4-20 mA input PWB for I/O Module	384131
Kit, 1% retrofit, 0-10 Vdc input PWB for I/O Module	384132
Reflector, external end, R500, 1 piece	43271
Quartz Plate, high grade, 6 in. x 10 in. x 0.090 in.	300292
Quartz Plate, high grade, 6 in. x 12 in. x 0.090 in.	300293

VPS Interconnect Cables

Cable lengths not listed in the table below may be available on a custom basis. Contact Heraeus Noblelight for assistance.

VPS Interconnect Cables

From	To	Description	Length		Heraeus Part Number
			(M)	(Ft)	
I/O Module	RF-1	VPS RF-1 Cable Assembly	2	6.6	293621
			4	13	293622
			6	19	295345
			8	26	293623 (std)
			11	36	293624
			14	45	293625
			17	55	293626
			21	68	293627
			26	85	293628
			31	101	293629
			38	124	295341
			46	151	295342
			54	177	295343
			61	200	295344
VPS Power Supply	I250B (with Modular Blower)	VPS HV Cable Assembly	2	6.6	295221
			4	13	295222
			6	19	295232
			8	26	295223 (std)
			11	36	295224
			14	45	295225
			17	55	295226
			21	68	295227
			26	85	295228
			31	101	295229
38	124	295231			

VPS Interconnect Cables (continued)

From	To	Description	Length		Heraeus Part Number
			(M)	(Ft)	
VPS Power Supply	I25x (with Remote Cooling)	VPS HV Cable Assembly	2	6.6	295241
			4	13	295242
			6	19	295252
			8	26	295243 (std)
			11	36	295244
			14	45	295245
			17	55	295246
			21	68	295247
			26	85	295248
			31	101	295249
VPS Power Supply	I60x (with Remote Cooling)	VPS HV Cable Assembly	2	6.6	295281
			4	13	295282
			6	19	295292
			8	26	295283 (std)
			11	36	295284
			14	45	295285
			17	55	295286
			21	68	295287
			26	85	295288
			31	101	295289
3 ϕ Power Source	VPS Power Supply	IEC309/Bare Wire Optional Power Cord - European Plug 380/415 VAC	2	6.6	330511

VPS Interconnect Cables (continued)

From	To	Description	Length		Heraeus Part Number
			(M)	(Ft)	
VPS Power Supply	VPS Power Supply	Communication Bus Cables	2	6.6	512471
			4.5	16	512492 (std)
			6	20	512473
			8	26	512474
			11	36	512475
			14	46	512476
			17	56	512477
			21	69	512478
			26	85	512479
			31	102	512481
			38	124	512482
			45	147	512483
			60	196	512484
			75	246	512485
			90	295	512486
			105	344	512487
120	393	512488			

Numerical Listing of Replacement Parts

Numerical Listing of VPS Parts

Description	Heraeus Part Number
Switch, Air Pressure, S201, I250	26072
Switch, Air Pressure, S201	26079
Limit Switch, SPDT, Door interlock, SW101	26355
Handle, utility (for I250 and I600M)	30397
Transformer Kit, filament, 50/60 Hz, T201, T202, I600M	36505
O-ring, silicone, I256/I606 only (for air plenum opening)	85975
Screw, socket head, M6 (2 per irradiator handle)	110821
Air Flange Assembly (for I250 and I600M)	213912
Magnetron Kit, Mag A/Mag B pair, I600M	234323
K250 Filter set, polyester (5 pieces)	235908
K250 Motor, ½ HP, 50/60 Hz	245371
Hex nut, plastic, HV connector, J10 (for I250 and I600M)	254101
K250 Terminal block, 1-Pole, 4 circuit, gray	254271
K250 Terminal block, 1-Pole, 3 circuit, green/yellow (ground)	254276
Photodetector Assembly kit, direct view, A201 (for I250 and I600M)	255063
Harness Assembly, I25x, J10/J11	255183
Transformer Kit, filament, 50/60 Hz, I250, front, 7" leads, T201	256021
Transformer Kit, filament, 50/60 Hz, I250, rear, 12" leads, T202	256022
Magnetron Kit, I250, pair	256041
K250 Harness assembly	257062
Coil, RF Suppression, I250 L201/L202	257261
Air Flange Assembly, I252M, I602M, and I603M only	270811
K250 Impeller	271371
K250 Bearing/shaft assembly	275231
K250 Rivet, nylon, 0.25 diameter (10 pieces)	275232
K250 Scroll, replacement kit with rivets	275233
K250 Pulley and belt kit, 60 Hz	275236
K250 Pulley and belt kit, 50 Hz	275237
K250 Retrofit kit - Modular Blower for I250 irradiator system (includes K250 and components for 50/60Hz operation)	275701
Air dam (located behind filament transformers) (for I250 and I600M)	276311
Control Panel Assembly with overlay	291551
Diode, Dual SCR Model, 1400V, 40A, TH2 and TH3	291941

Numerical Listing of VPS Parts *(continued)*

Description	Heraeus Part Number
Circuit Breaker, 2-pole, 4A, 480V, CB100, for VPS-6 only	292223
Rocker Switch, DPST, 250V, 4A, S100	292241
Modular Blower, 380-480V (K250 only) Kit, OPTIONAL	296111
Modular Blower, 200-240V (K250 only) Kit, OPTIONAL	296112
Handle, chassis, pocket pull, K250	296252
Knob, Power Level	296691
Capacitor, oil-filled, 250V, 160 MFD, C101 and C102, for VPS-4 only	297591
Capacitor, oil-filled, 480V, 50 MFD, C101 and C102, for VPS-6 only	297592
Circuit Breaker, 3A, 3-pole, 480V, CB102, optional for VPS-4 only	298853
Circuit Breaker, 40A, 3-pole, 480V, CB101, for VPS-4 and VPS-6	302411
Varistor, 10KV, VR1, VR2	302641
LCD Assembly Kit	325061
Lanyard, VPS Door	326612
Clip, HV, wire	326632
HV Diode Assembly	328764
Circuit Breaker, 1.6A, 3-pole, 480V, CB102, optional for VPS-6 only	329713
Baffle-Cooling, polycarbonate	330011
Fuse, 250V, 4A, Slow-blo, 5x20 mm, 150A interrupt capacity, F1-F3 on HV PWB	341197
Transformer, Control, T100	501921
Bolt, captive, M8, I256/I606 only (for tower mounting)	511181
Spring, compression, I256M/I606 only (for tower mounting)	511391
Harness Assembly, J10/J11/J30, I600M	512691
Circuit Breaker, 2-pole, 8A, 480V, CB100, for VPS-4 only	528541
Air Baffle, I256M only	529131
Air Baffle, I606M only	529132
K250 Belt-timing, 5mm, Power Grip GT, 90 teeth	555071
K250 Pulley set screw, M4	555471
I600M Bulb, UV, BT11D, single bulb (optional)	558454
I600M Bulb Kit, 10", BT11D, 11 mm, 1 bulb *	558464
I600M Bulb, UV, BT13H+, single bulb (optional)	558471
I600M Bulb, UV, BT13H, single bulb (standard)	558472
I600M Bulb, UV, BT13D, single bulb (optional)	558474
I600M Bulb, UV, BT13M, single bulb (optional)	558475
I600M Bulb, UV, BT13V, single bulb (optional)	558477
I600M Bulb, UV, BT13Q, single bulb (optional)	558478
I600M Bulb Kit, 10", BT13H+, 13 mm, 1 bulb *	558481
I600M Bulb Kit, 10", BT13H, 13 mm, 1 bulb *	558482

Numerical Listing of VPS Parts *(continued)*

Description	Heraeus Part Number
I600M Bulb Kit, 10", BT13D, 13 mm, 1 bulb *	558484
I600M Bulb Kit, 10", BT13M, 13 mm, 1 bulb *	558485
I600M Bulb Kit, 10", BT13V, 13 mm, 1 bulb *	558487
I600M Bulb Kit, 10", BT13Q, 13 mm, 1 bulb *	558488
I250 Bulb, UV, BL9H+, 9 mm single bulb (optional)	558491
I250 Bulb, UV, BL9H7, 9 mm single bulb (standard)	558492
I250 Bulb, UV, BL9A7, 9 mm single bulb (optional)	558493
I250 Bulb, UV, BL9D7, 9 mm single bulb (optional)	558494
I250 Bulb, UV, BL9M7, 9 mm single bulb (optional)	558495
I250 Bulb, UV, BL9V7, 9 mm single bulb (optional)	558497
I250 Bulb, UV, BL9Q7, 9 mm single bulb (optional)	558498
I250 Bulb Kit, 10", BL9H+, 9 mm, 1 bulb *	558501
I250 Bulb Kit, 10", BL9H7, 9 mm, 1 bulb *	558502
I250 Bulb Kit, 10", BL9A7, 9 mm, 1 bulb *	558503
I250 Bulb Kit, 10", BL9D7, 9 mm, 1 bulb *	558504
I250 Bulb Kit, 10", BL9M7, 9 mm, 1 bulb *	558505
I250 Bulb Kit, 10", BL9V7, 9 mm, 1 bulb *	558507
I250 Bulb Kit, 10", BL9Q7, 9 mm, 1 bulb *	558508
I600M Bulb Kit, 10", BT11D, 11 mm, 2 bulbs *	570224
I600M Bulb Kit, 10", BT11D, 11 mm, 3 bulbs *	570234
I600M Bulb Kit, 10", BT13H+, 13 mm, 2 bulbs *	570241
I600M Bulb Kit, 10", BT13H, 13 mm, 2 bulbs *	570242
I600M Bulb Kit, 10", BT13D, 13 mm, 2 bulbs *	570244
I600M Bulb Kit, 10", BT13V, 13 mm, 2 bulbs *	570247
I600M Bulb Kit, 10", BT13H+, 13 mm, 3 bulbs *	570251
I600M Bulb Kit, 10", BT13H, 13 mm, 3 bulbs *	570252
I600M Bulb Kit, 10", BT13D, 13 mm, 3 bulbs *	570254
I600M Bulb Kit, 10", BT13V, 13 mm, 3 bulbs *	570257
I250 Bulb Kit, 10", BL9H+, 9 mm, 2 bulbs *	570261
I250 Bulb Kit, 10", BL9H7, 9 mm, 2 bulbs *	570262
I250 Bulb Kit, 10", BL9D7, 9 mm, 2 bulbs *	570264
I250 Bulb Kit, 10", BL9V7, 9 mm, 2 bulbs *	570267
I250 Bulb Kit, 10", BL9H+, 9 mm, 3 bulbs *	570271
I250 Bulb Kit, 10", BL9H7, 9 mm, 3 bulbs *	570272
I250 Bulb Kit, 10", BL9D7, 9 mm, 3 bulbs *	570274
I250 Bulb Kit, 10", BL9V7, 9 mm, 3 bulbs *	570277
I600M Bulb Lab kit (contains one each of BT13H, BT13D, and BT13V) *	570352

Numerical Listing of VPS Parts *(continued)*

Description	Heraeus Part Number
I250 Bulb Lab Kit (contains one each of BL9H7, BL9D7, BL9V7)*	570353
Air Flange Assembly, I251M and I601M only	573901
Kit, Contactor, Power, 3-pole with auxiliary, 37A, 24 VAC coil, K100	580341
RF Screen assembly replacement kit, Quick Change Screen, 10-inch systems	581742
Transformer Kit, HV, 200-480V, 50/60 Hz, T101-T106	582084
Muffin Fan, 24 Vdc, 230 cfm, B101 and B102	589471
HV PWB Assembly Kit	80126781
RF gasket kit, 10-inch systems (contains pairs of reflector end and reflector elastomer gaskets)	80130191
Mag PWB Assembly Kit	80130227
Control PWB Assembly Kit	80130229
End Reflector Kit, R500 (1 pair) (standard) (includes elastomer gaskets)	80130626
End Reflector Kit, R500 (1 pair), "209" hole location (includes elastomer gaskets)	80130627
I600M Reflector assembly kit, R500, swept (includes main reflector, two end reflectors, and elastomer gaskets)	80130714
I600M Reflector assembly kit, R500, non-swept (includes main reflector, 2 end reflectors, and elastomer gaskets)	80130715
I25x Reflector assembly kit, R500, non-swept (includes main QCS reflector, 2 R500 end reflectors, and elastomer gaskets)	80130716
I25x Reflector assembly kit, R500, swept (includes main QCS reflector, two R500 end reflectors, and elastomer gaskets)	80130717
I25x Reflector assembly kit, Dichroic, basic (cold/R500) (includes dichroic main QCS reflector, 2 R500 end reflectors, and elastomer gaskets)	80131718
I600M Reflector assembly kit, Dichroic, non-swept (cold/R500) (includes dichroic main reflector, 2 R500 end reflectors, and elastomer gaskets)	80130719
I600M Reflector assembly kit, Dichroic, swept (cold/R500) (includes dichroic main reflector, 2 R500 end reflectors, and elastomer gaskets)	80130720
I600M Reflector assembly kit, R500, swept, "209" (includes main reflector, 2 "209" end reflectors, and elastomer gaskets)	80130721
I600M Reflector assembly kit, R500, non-swept (includes main reflector, 2 "209" end reflectors, and elastomer gaskets)	80130722
I25x Reflector assembly kit, Dichroic Plus, non-swept (cold/R500) (includes dichroic main QCS reflector, 2 R500 end reflectors, and elastomer gaskets)	80130723
I25x Reflector assembly kit, Dichroic Plus, non-swept "209" (cold/R500) (includes dichroic main QCS reflector, 2 R500 "209" end reflectors, and elastomer gaskets)	80130724
I600M Reflector assembly kit, Dichroic Plus, non-swept (cold/R500) (includes dichroic main reflector, 2 R500 end reflectors, and elastomer gaskets)	80130725
I600M Reflector assembly kit, Dichroic Plus, swept (cold/R500) (includes dichroic main reflector, 2 R500 end reflectors, and elastomer gaskets)	80130726
I600M Reflector assembly kit, Dichroic Plus, non-swept "209" (includes dichroic main reflector, 2 "209" end reflectors, and elastomer gaskets)	80130727
I600M Reflector assembly kit, Dichroic Plus, swept "209" (includes dichroic main reflector, 2 "209" end reflectors, and elastomer gaskets)	80130728

Numerical Listing of VPS Parts *(continued)*

Description	Heraeus Part Number
I25x Basic PM kit, contains 9 mm UV bulb (BL9H7), QCS RF screen kit, and QCS R500 swept reflector kit with elastomer gaskets	80130863
I25x Basic PM kit, contains 9 mm UV bulb (BL9D7), QCS RF screen kit, and QCS R500 swept reflector kit with elastomer gaskets	80130864
I600M Basic PM kit, contains 13 mm UV bulb (BT13H), QCS RF screen kit, and QCS R500 swept reflector kit with elastomer gaskets	80130865
I600M Basic PM kit, contains 13 mm UV bulb (BT13D), QCS RF screen kit, and QCS R500 swept reflector kit with elastomer gaskets	80130866
I600M Basic PM kit, contains 13 mm UV bulb (BT13H+), QCS RF screen kit, and QCS R500 swept reflector kit with elastomer gaskets	80130867
I600M Basic PM kit, contains 13 mm UV bulb (BT13H), QCS RF screen kit, and QCS R500 non-swept reflector kit with elastomer gaskets	80130868
I600M Basic PM kit, contains 13 mm UV bulb (BT13D), QCS RF screen kit, and QCS R500 non-swept reflector kit with elastomer gaskets	80130869
Kit, Reflector hardware (contains additional hardware for older-style screens)	80131353
I25x Deluxe PM kit, contains 9 mm H bulb (BL9H7), QCS RF screen kit, QCS R500 swept reflector kit with elastomer gaskets, I25x magnetron kit, photocell, and pressure switch	80132590
I600M Deluxe PM kit, contains 13 mm UV bulb (BT13H), QCS RF screen kit, QCS R500 swept reflector kit with elastomer gaskets, magnetron kit, photocell, and pressure switch	80132591
I600M Deluxe PM kit, contains 13 mm UV bulb (BT13H+), QCS RF screen kit, QCS R500 swept reflector kit with elastomer gaskets, magnetron kit, photocell, and pressure switch	80132592
I25x Deluxe PM kit, contains 9 mm D bulb (BL9D7), QCS RF screen kit, QCS R500 swept reflector kit with elastomer gaskets, I25x magnetron kit, photocell, and pressure switch	80135607
I600M Deluxe PM kit, contains 13 mm UV bulb (BT13D), QCS RF screen kit, QCS R500 swept reflector kit with elastomer gaskets, magnetron kit, photocell, and pressure switch	80135608
I600M Deluxe PM kit, contains 13 mm UV bulb (BT13H), QCS RF screen kit, QCS R500 non-swept reflector kit with "209" end reflectors and elastomer gaskets, magnetron kit, and photocell	80135609

Heraeus Noblelight America LLC

910 Clopper Road
Gaithersburg, MD 20878-1357 USA
www.heraeus-noblelight.com/fusionuv

Phone: +1 301-527-2660
Fax: (Technical Service) +1 301-527-2663
Fax: (Sales) +1 301-527-2661
email: info.hna.uvp@heraeus.com

Heraeus Noblelight GmbH

Heraeusstraße 12-14
63450 Hanau, Germany

Phone: +49 6181 35 4966
Fax: +49 6181 35 9926
email: hng-uv@heraeus.com

Heraeus K.K.

Noblelight Division
Sumitomo Fudosan Otowa
Bldg. 1F, 2F, 5F
2-9-3 Otsuka, Bunkyo-ku,
112-0012, Tokyo Japan

Phone: +81 3 6902 6602
Fax: +81 3 6902 6613
email: info.hkk@heraeus.com

Heraeus Noblelight (Shenyang) Ltd.

Shanghai Branch
2F, Building 5, No. 406 Guilin Road
Xuhui District
Shanghai 200233, P.R. China

Phone: +86 (21) 3357 5555
Fax: +86 (21) 3357 5333
email: info.hns@heraeus.com